

## FRAMES

---

### THREE SIDED FRAMES WITH INTEGRAL STOPS SERIES F FRAMES

#### Specifications

1. Frames shall be manufactured of 12, 14 or 16 gage Steel per ASTM A 1008, 568 & 569 OR A60 Galv. Per ASTM A924 & A653.
2. F14 and F16 Frames shall be knocked down for field assembly. Milters shall have a precision hairline joint when assembled. Optionally the corners can be welded and ground smooth. F12 Corners shall be arc-welded and ground smooth, and frames shall be provided with steel bottom spreader.
3. Heads shall be reinforced for surface applied closers, holders, or brackets when required.
4. Dual purpose hinge reinforcements shall be 3/16" thick. It comes equipped with galvaneal back-up filler plate for standard weight hinges. Conversion from standard weight to heavy weight hinges is done by removing the filler plate. All reinforcements for hinges and strikes shall have steel-plaster guards.
5. All frames shall be prepared to receive G.J.64 type door silencers; three for single frame and two for pair frame. (Silencers by others)
6. Frames are available with appropriate anchors as required to suit wall conditions. Frames shall have floor clips at bottom of all jambs for attachment to finished floor. See Anchors data sheet for details.
7. Heads of pair frames over 4'-0" wide and up shall be prepared with a universal "knock-out" or Mortised Flush Bolt prep. as required.
8. Frames shall be prime painted by Pioneer's exclusive painting process, consisting of a three stage wash, phosphate treatment, Electrostatic Spray painting and oven baking in compliance with ANSI A250.10 and HMMA840-TN01.
9. Frames shall be furnished with WHI or UL listing mark (label) as required. Frames must be installed in compliance with NFPA 80 and per Pioneer's Installation Instructions.
10. Frame construction complies with ANSI A 250.8 (SDI -100) and HMMA 820.
11. Hardware preparations and reinforcements comply with ANSI A250.6. and ANSI/BHMA A156.115.

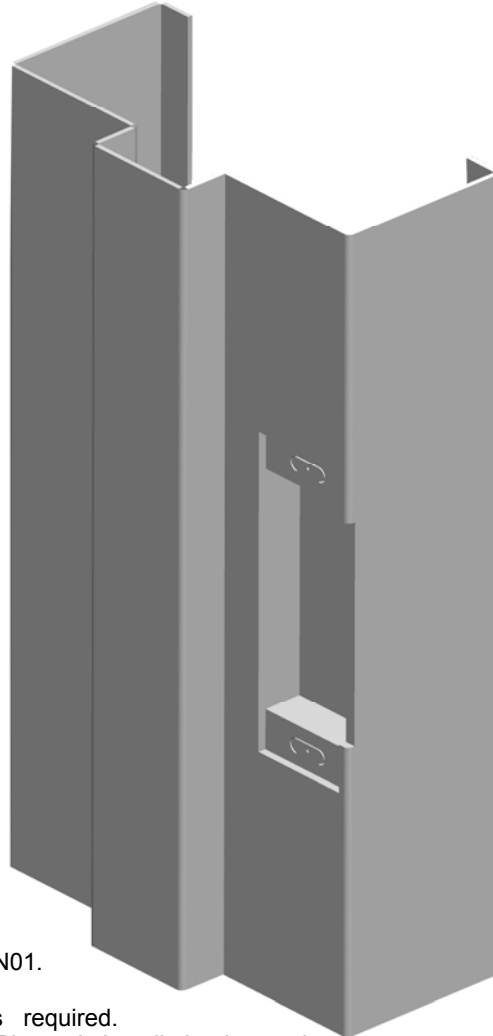

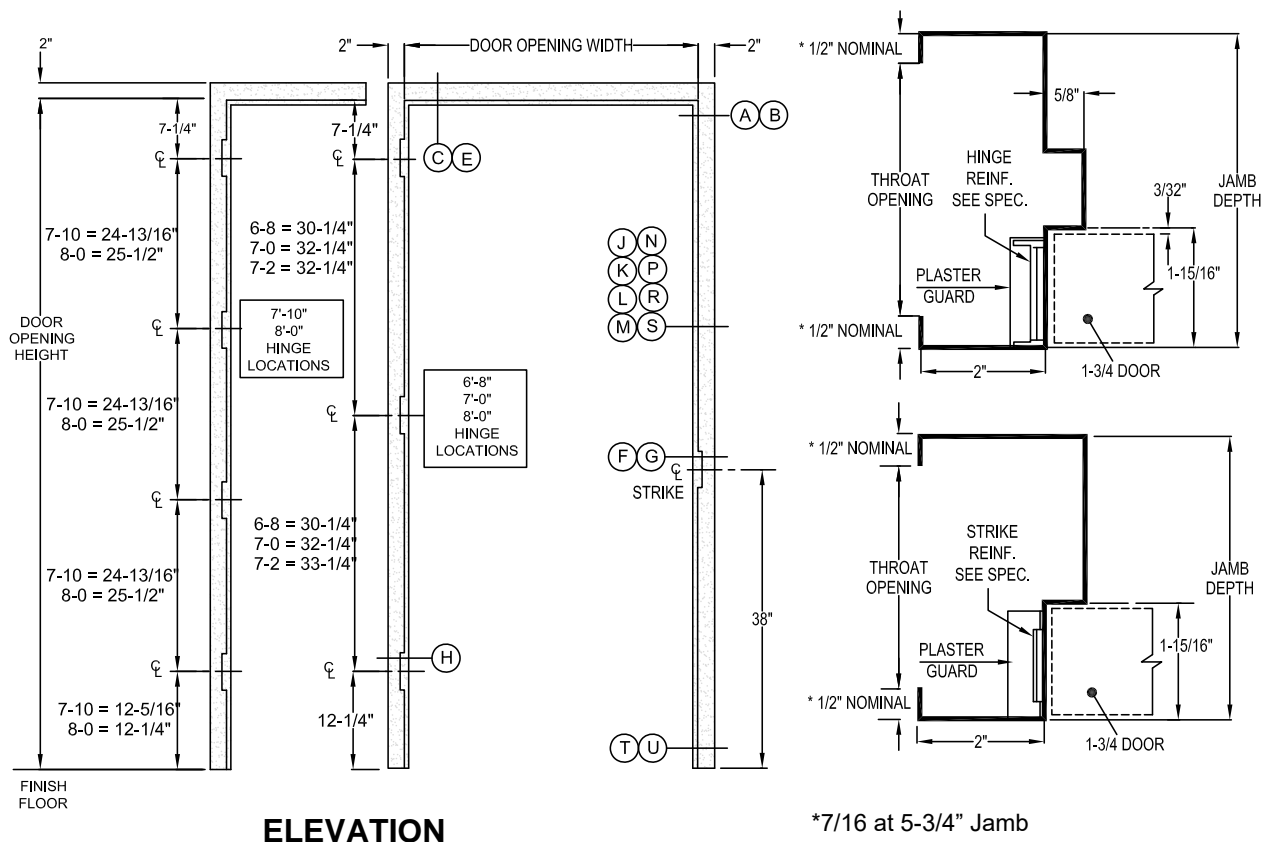

**STANDARD SIZES\***

DOOR OPENING HEIGHT	DOOR OPENING WIDTH		JAMB DEPTH
	SINGLE	PAIR	
	2'-0"		3" MINIMUM
	2'-4"		
	2'-6"	4'-8"	
6'-8"	2'-8"	5'-0"	
7'-0"	2'-10"	5'-4"	
7'-2"	3'-0"	6'-0"	
7'-10"	3'-4"	6'-8"	
8'-0"	3'-6"	7'-0"	
	3'-8"	8'-0"	
	3'-10"		
	4'-0"		

\* For other sizes consult factory.

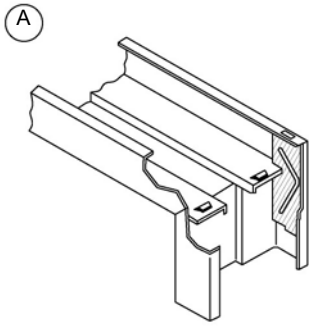

CORNER SECTION

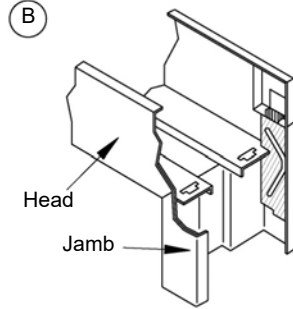

CORNER SECTION  
4" HEAD

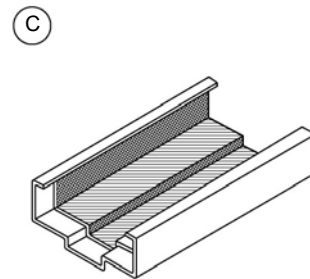

CLOSER REINF.  
SLEEVE

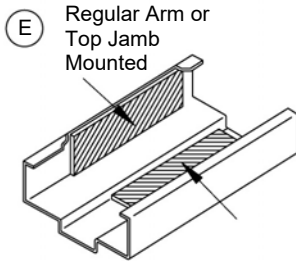

CLOSER REINF (WELD-IN)  
(Available for various trim  
and stop applied devices)

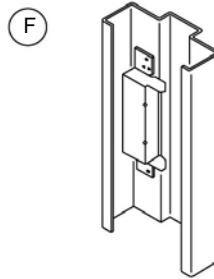

ASA 4-7/8" STD.  
1-PIECE STRIKE REINF.  
WITH PLASTER GUARD

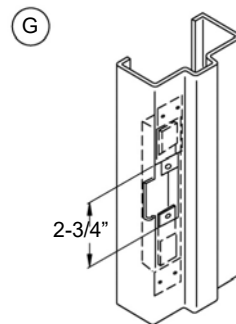

STRIKE PREPARATION  
2-3/4" (Optional)

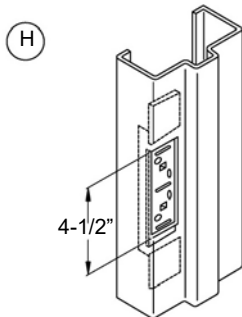

DUAL PURPOSE MORTISE  
HINGE PREPARATION WITH  
BACK-UP FILLER PLATE

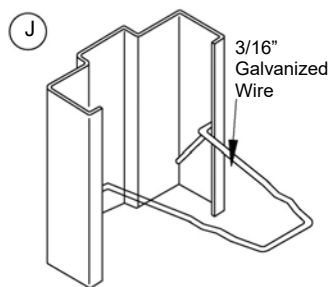

WIRE MASONRY ANCHOR  
(Adjustable to desired Jamb  
depth)

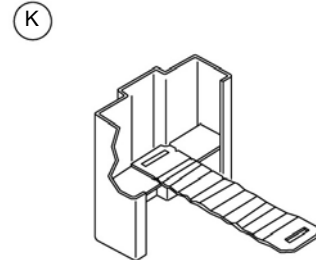

MASONRY  
T ANCHOR

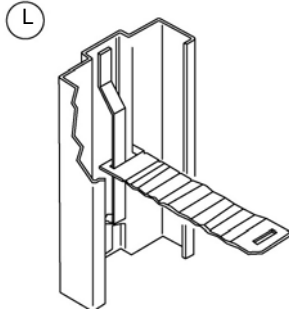

**YOKE & STRAP  
MASONRY ANCHOR**

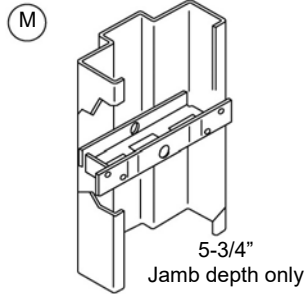

**COMBINATION ANCHOR**  
for Steel Stud, Wood Stud  
and Existing Masonry

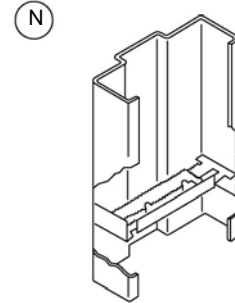

**STEEL STUD ANCHOR**  
(Adjustable to desired Jamb  
depth)

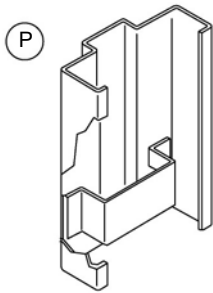

**CLOSED CHANNEL  
STEEL STUD ANCHOR**  
(Specify stud width)

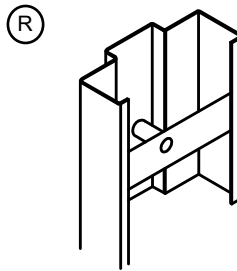

**EXISTING MASONRY ANCHOR**

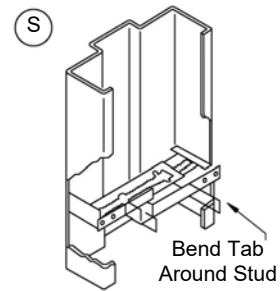

**WOOD STUD ANCHOR**  
(Adjustable to desired Jamb  
depth)

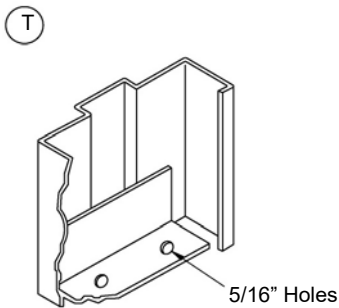

**BASE ANCHOR**

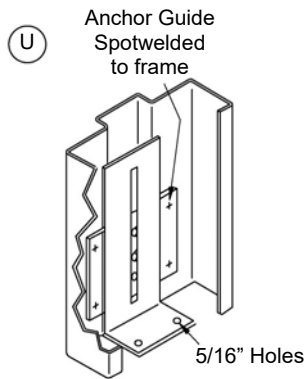

**ADJUSTABLE FLOOR KNEE**

**NOTE:** In order to provide our Customers with the finest Products, manufactured in the Most up to date manner, Pioneer Industries reserves the right to make design or specific construction changes without notice.

Pioneer Industries will not be Responsible for errors incurred By other parties through the use Of this data sheet without written confirmation from Pioneer. Other trades should contact Pioneer for exact hardware locations.